

() + 1
+ 1

() +

x Master Device

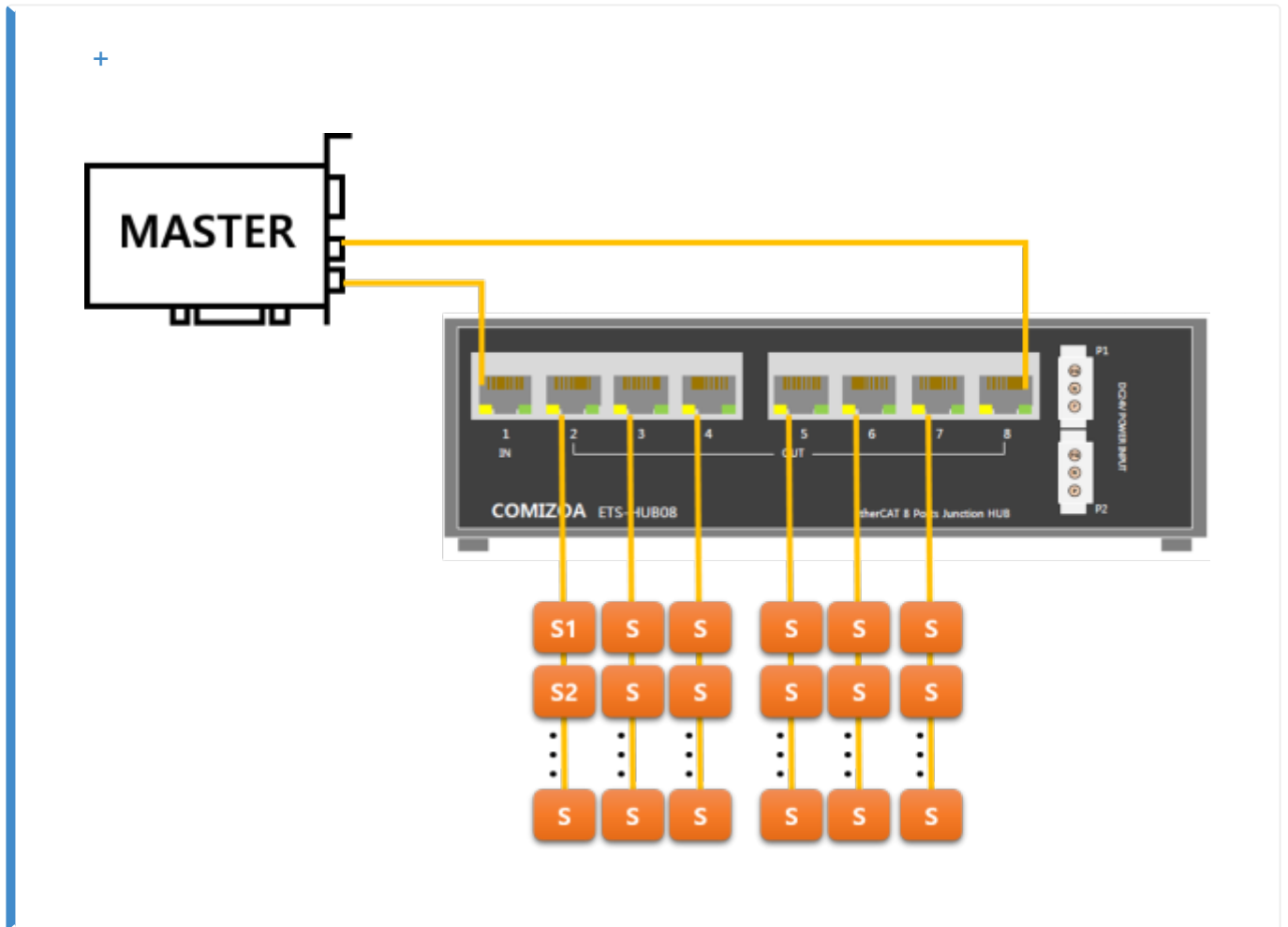

- Ring Topology Hub 가 Tree 가
- Hub

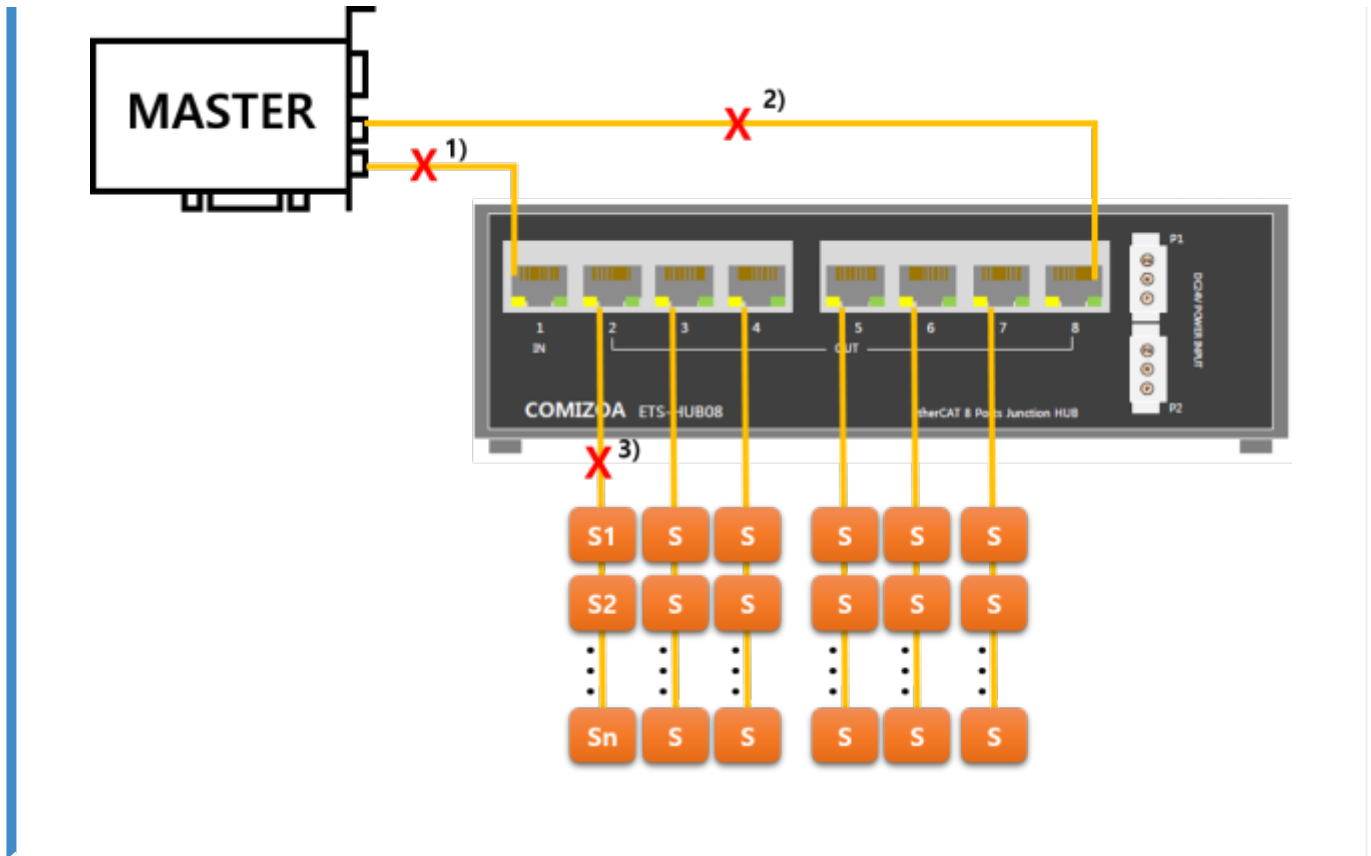

- 1), 2)
- 3) , S1 ~ Sn Disconnect .

From:
<http://comizoa.co.kr/info/> - -

Permanent link:
http://comizoa.co.kr/info/doku.php?id=platform:ethercat:1_setup:05_topology:40_ringtree&rev=1608096777

Last update: 2024/07/08 18:22